



METTLER TOLEDO

SOLO[®] XL
Automatic
Wrapper
Quick
Reference
Guide

64081951
Rev 02

Fold First



NO POSTAGE
NECESSARY IF
MAILED IN THE
UNITED STATES

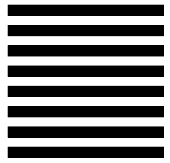

BUSINESS REPLY MAIL
FIRST CLASS PERMIT NO. 414 COLUMBUS, OH

POSTAGE WILL BE PAID BY ADDRESSEE

Mettler-Toledo, LLC
Retail Quality Manager - MTWR
P.O. Box 1705
Columbus, OH 43216
USA







Please seal with tape.

Contents

Operator Safety	2
Control Panel	3
Startup	4
Program and Film Tension Settings	5
Loading Trays	6
Status Codes	7
Sealing Belt Temperature	7
Loading Film	8
Daily Cleaning Overview	10
Daily Cleaning Detail	11
Troubleshooting	16
Tray Reference XL-13	17
Tray Reference XL-11	18
Status Codes	19

Operator Safety

	<p> WARNING</p> <p>The machine has an electrically heated sealing belt. Do not touch this belt.</p>
---	---

	<p> WARNING</p> <p>Do not put your hands beyond the Infeed Door or beyond the Sealing Belt exit opening while the machine is operating or powering up. On powerup, the Model 645 will run a self-test. During the self-test, Infeed Belts are in motion and other motors are running. Do not place materials on the belts during this test.</p>
---	---

Read this manual before operating or servicing this equipment

Follow these instructions carefully.

Do not allow untrained personnel to operator, clean, inspect, maintain, service, or tamper with this equipment.

Always disconnect this equipment from the power source before cleaning or performing maintenance.

Observe all posted warning decals on the machine.

The machine has an electrically heated sealing belt. Be careful when working near the belt.

Keep hands clear of the infeed door and the sealing belt exit opening while the machine is operating.

Only wrap the indicated tray sizes described in the Tray Reference section of this manual.

Control Panel

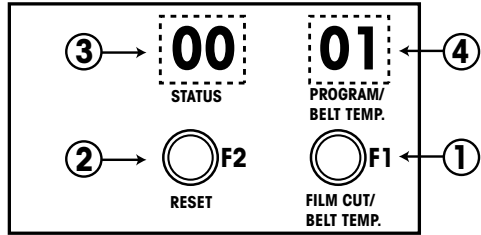

①

F1 Button

Used for:

- Film Cutting
- Change Program and Sealing Belt Temperature

②

F2 Button

Used for:

- Reset Machine
- Change Program and Sealing Belt Temperature

③

Status Display

- Shows machine "Status" codes

④

Program/Belt Temp Display

- Shows film wrapping Program setting
- Shows Sealing Belt Temperature

Startup

Operator Action Display Panel

Turn Power Switch from **0** (off) to **I** (on) to turn on the machine power.

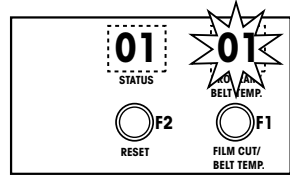
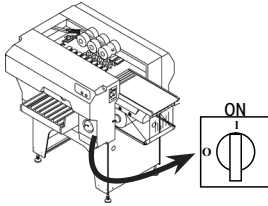

- Status display shows 01.
- Program/Belt Temp display will blink.

Keep hands clear of the machine infeed and discharge areas, then press the **F2** button to reset the machine.

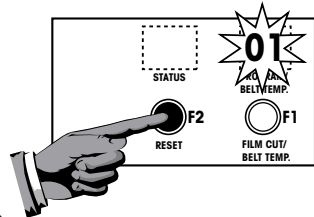

The machine will start to run a power up self test. During the test, the conveyors are in motion. Make sure the belts are clear of any items before pressing the button.

- Status display will be blank.
- Program/Belt Temp display will blink.

Wait for the Sealing Belt to reach the programmed temperature before starting to wrap packages. The display will continue to blink until the temperature value is reached.

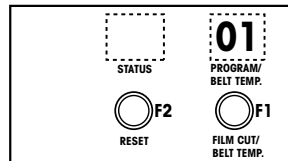

- When the Program/Belt Temp display stops blinking, the machine is ready to wrap.

Program and Film Tension Settings

Operator Action Display Panel

Press and hold the **F2** button for 2 seconds.

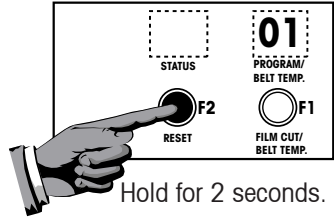

Continue to hold the **F2** button and then press the **F1** button repeatedly until the desired program number is displayed.

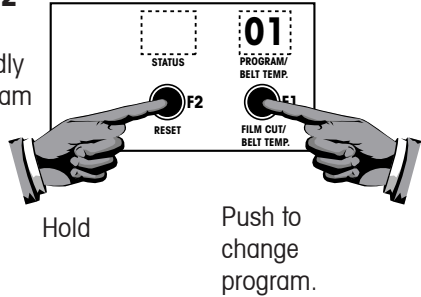

When the desired program is displayed, release the **F2** button.

Program Settings

01	Highest Tension	Normal size trays with height less than 3 inches.
03	Reduced Tension	For larger trays or trays with height greater than 3 inches.
05	Reduced Tension	Less tension than program 03 for larger trays, trays with height greater than 3 inches, or less stable trays.
31	Black Trays	For use with black trays.
41	Black Trays	For use with black trays that are non-tacky or recycled black trays.
19	No Wrap	Weigh and Label only.

Loading Trays

Operator Action Display Panel

Trays must be sufficiently rigid and the item must be contained completely in the tray.

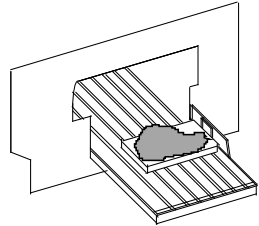

Place the tray on the Infeed Belt and against the Start Switch to start the machine.

The trays must be in line against the Start Switch for proper wrapping.

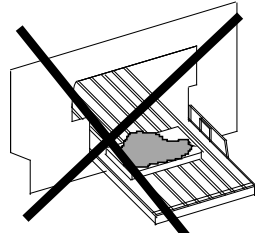

Allow belts to stop before placing the next tray.

Trays must be aligned square with the Infeed Conveyor.

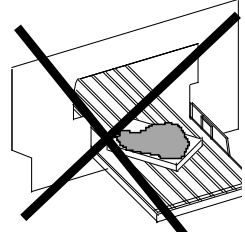

Correct

Incorrect

All items must be completely contained within the tray.

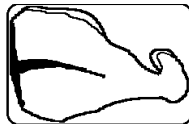

The height must be less than 5.5".

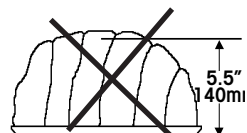
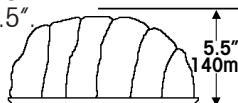

Status Codes

At the back of this manual, you will find a list describing the status codes and the steps to take to clear the condition.

Operator Action Display Panel

When a status condition occurs, the wrapper will stop operating and a code will appear in the STATUS display box.

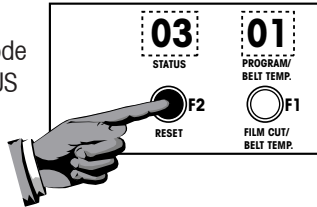

After the condition has been corrected, press the **F2** button to reset the wrapper. The STATUS display should then be blank and the machine is ready to wrap.

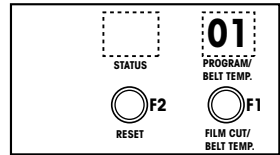

Sealing Belt Temperature

00 to 30

- 00 Heater Off
- 01 78°C (172°F)
- 02 81°C (178°F)
up to
- 30 165°C (329°F) Max

Note:

Each step = 3°C (5.5°F)

Operator Action Display Panel

To Change Sealing Belt temperature, press and hold button F1 for 2 seconds.

While holding button F1, select the new temperature by pressing button F2 until the desired temperature value displays.

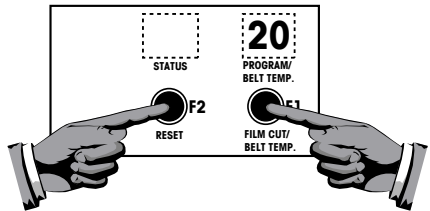

Recommended normal operating temperature range is between 18-20.

- 18 = 122°C (251°F)
- 20 = 128°C (262°F)

Loading Film

Operator Action

- Turn the main switch to the O (off) position. See item (E) below right for location.

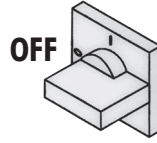

- Open the top cover. (M)
- Lift the sealing belt by the handle. CAUTION: HOT (L)
- Release the bobbin (H) from the housing by moving the latch (X) toward the operator side. Pivot the bobbin outwards.
- Hold the bobbin and rotate the handwheel (Z) counter-clockwise to release the bobbin lock.

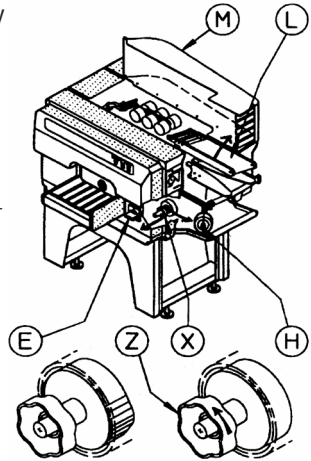

- Insert the film roll onto the bobbin shaft until the roll edge touches the core reference disk (Y). Film should come off the top of the roll.
- Rotate the handwheel clockwise to endstop (Z).

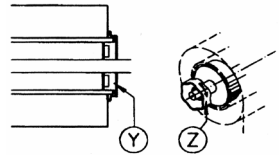

Loading Film (cont.)

Operator Action

- Move the bobbin back to the work position and lock it into place.

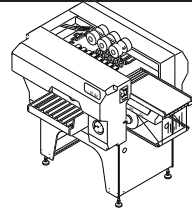

- Insert the film under the dancer roller bar (K), over the film curved rollers (I), and on to the film folders (J), according to the directions on the decal.
- Pull the film into the machine to allow sealing belt to close.

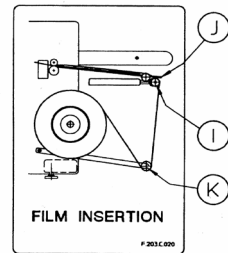

- Gently lower the sealing belt to the work position. Do not allow the belt to slam as this may alter alignment and cause wrapping problems. Pull film out approximately 1 meter (3 feet) until it widens.
- Lower the top cover to the work position. (M)
- Turn main power switch to I (E).
- Pull film back over sealing belt and out of the machine enough to ensure even tracking.
- While holding film, press and hold button **F1** for more than 5 seconds to cut the film.

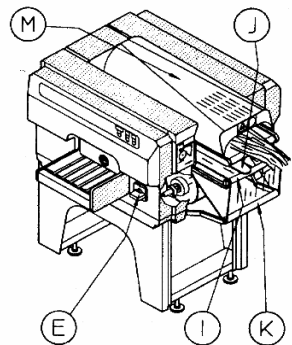

Daily Cleaning Overview

Warning!
Turn the Power Switch at the wrapper to OFF before cleaning!

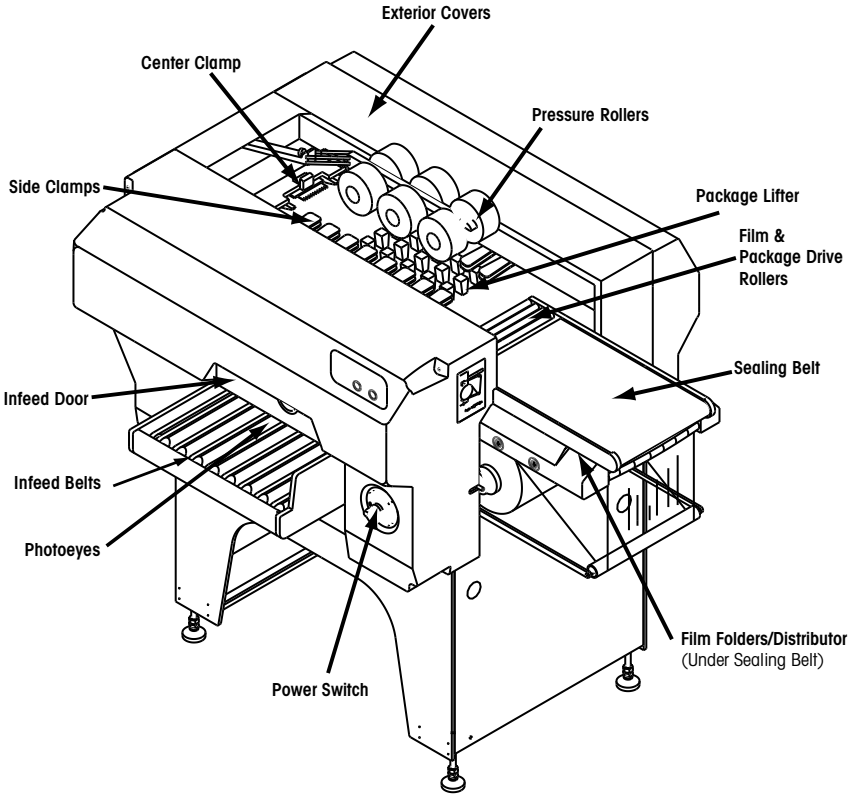

Important!
After all cleaning is completed,
turn the wrapper Power Switch
back to ON.

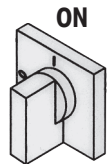

Daily Cleaning Details

Clean the sealing belt with a soft cloth dampened with hot water. **Caution! The belt may be hot. Allow the belt to cool before cleaning.**



Clean the film drive roller (A) with a soft cloth dampened with isopropyl alcohol (recommended) or hot water. Clean the package drive roller (B) with a soft cloth dampened with hot water. Remove any debris from the roller.

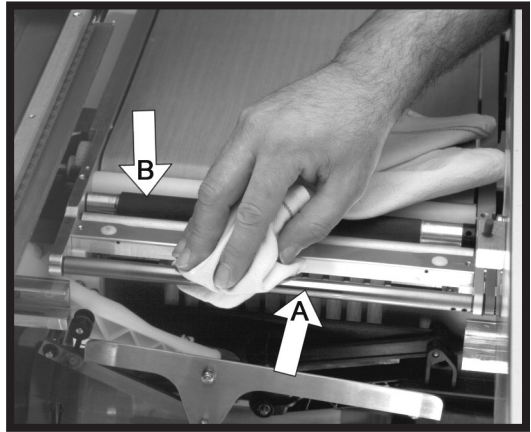

If your unit is a SOLO® XL Combo, push the printer shelf back before raising the Sealing Belt.

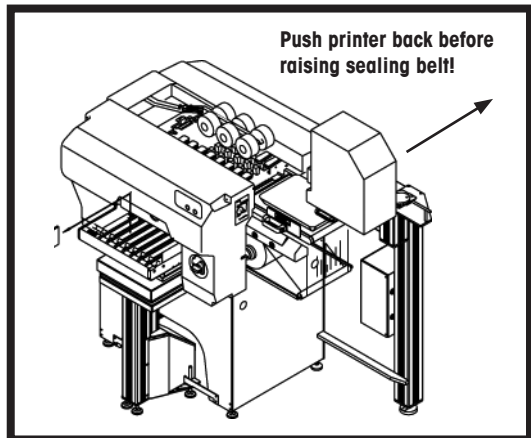

Daily Cleaning Details

Raise the sealing belt using the handle for access to the distributor, film clamp, and folders below it. **Caution! The belt may be hot.** Clean the film folders, distributor, and curved rollers with a soft cloth dampened with hot water.



While the Sealing Belt is raised, clean the distributor film clamp with a soft cloth dampened with hot water. When lowering the sealing belt, hold the handle and lower it gently to avoid alignment problems.



Remove any debris from the comb. Clean the film gripper on the center clamp with a soft cloth dampened with isopropyl alcohol (recommended) or hot water. Wipe the surfaces dry when done cleaning. (This must be dry before using the machine.)



Daily Cleaning Details

Clean the roller on the center clamp with a soft cloth dampened with hot water. Remove any debris from the roller.



Clean the tops (A) of the side clamps with a soft cloth dampened with hot water. Press down on each of the clamps (B) to expose the gripper pads (C). Clean each of the pads (C) with a soft cloth dampened with hot water. Allow to dry before using the machine.

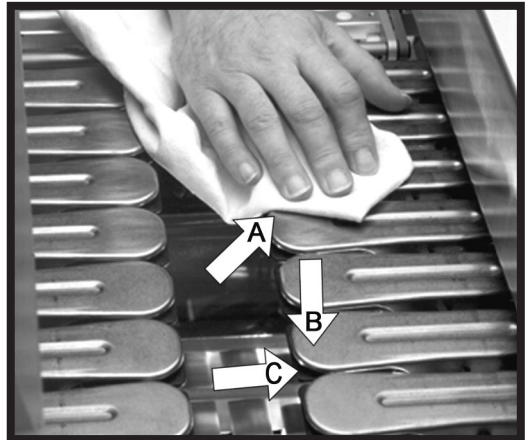

Clean the pressure rollers with a soft cloth dampened with hot water. Remove any debris from the rollers.

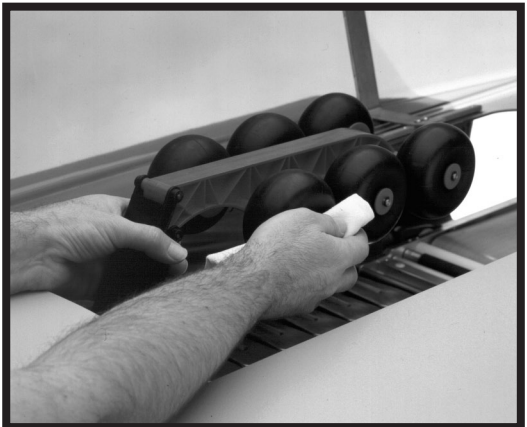

Daily Cleaning Details

Raise the lifter by pulling it up. Clean the lifter supports with a soft cloth dampened with hot water. Remove any debris from the supports.



Clean the Infeed Belts and the Infeed Door with a soft cloth dampened with hot water. Wipe the belts and rollers to remove any grease or debris.



If your system is a SOLO® XL Combo, remove the scale risers, then the scale platter by lifting the platter up and out. Clean both daily using hot water, soap, and a brush to clean the slots.

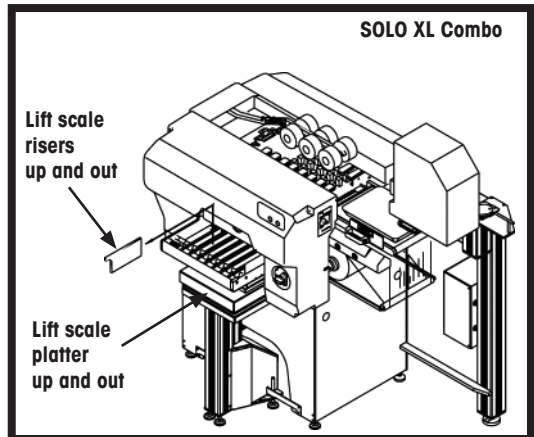

Daily Cleaning Details

Clean the right (A) and left (B) vertical photoeyes and the horizontal photoeyes (C) with a soft cloth dampened with hot water. **Do not use a paper towel or other abrasive material.** It will scratch the photoeye lens. Clean Start Switch (D), except XL Combo, with a soft cloth dampened with hot water. Remove any debris. Do not use any sharp objects to clean the switch cover.

Clean all exterior surfaces with a soft cloth dampened with hot water.

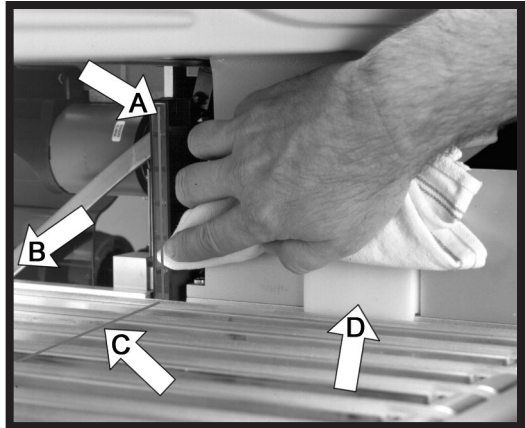

Troubleshooting

Symptom	Cause	Solution
Film Tearing or Film Tracking Poorly	Bad Roll of film.	Replace film with new roll.
Trays left open, poor overwrap, or no overwrap	Film Pulling out of center clamp.	Clean center clamp.
	Film Pulling out of side clamps.	Near end of roll - change roll. Clean side clamp gripper pads and allow to dry.
Not picking film	Sealing Belt not in correct or closed position.	Lift and reclose Sealing Belt.
	Film not loaded properly.	Reload Film.
	Center clamp dirty.	Clean center clamp and allow to dry.
	Film wrapped around distributor film roller.	Remove any film or debris from distributor film roller.
Error 61 display on trays normally wrapped	Infeed belts slipping.	Clean and dry infeed belts.
Error 99	Photoeyes dirty.	Clean photoeyes and infeed door.
Short Overwrap	Rollers on sealing belt dirty.	Clean rollers on sealing belt.

Tray Reference

XL-13

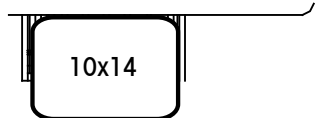
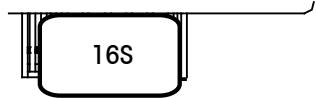
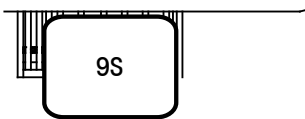
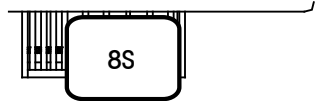
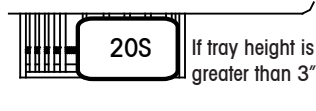
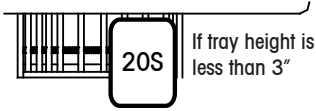
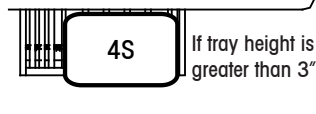
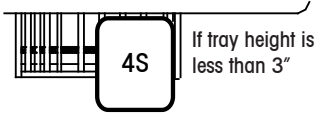
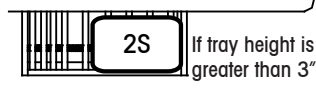
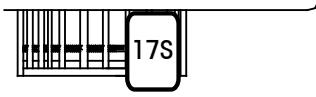

Tray Reference XL-11

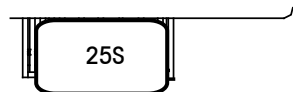
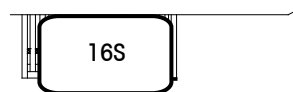
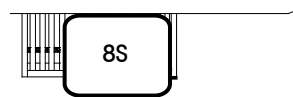
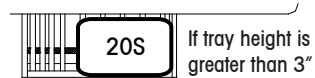
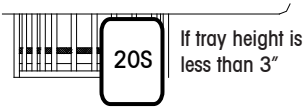
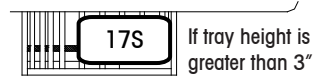
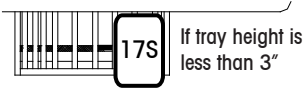
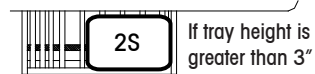
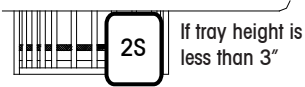
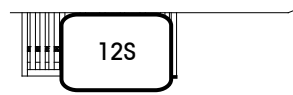
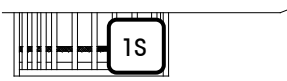

Status Codes

Code	Description	Action
00	End of Emergency	Press the Reset Button F2.
01	Waiting to Start the Program.	Press the Reset Button F2.
03	Safety Stop Caused by open Infeed Door. - or - Top Cover open.	Release the Infeed Door. - or - Close Top Cover. Press Reset Button F2.
04	Package Jam in machine.	Open top cover, remove jammed package, then close cover. Press the Reset Button F2.
06-54	Internal machine errors.	Remove any debris or packages from machine. Press the Reset Button F2. If problem persists, call for service.
60	Double package or tray fed too soon or too close together. - or - Photoeyes dirty.	Feed trays only when belts are stopped. Press the reset button F2 to back trays out of machine. Remove one tray and press Reset F2 again. - or - Clean photoeyes. If the error persists, call for service.
61	Package too long. - or - Photoeyes dirty. - or - Feed Rollers/Belts dirty.	Turn the package 90 degrees. - or - Clean photoeyes. - or - Clean feed rollers/belts. If the error persists, call for service.

Status Codes

Code	Description	Action
62	Package too small. - or - Photoeyes dirty.	Turn the package 90 degrees - or - Clean Photoeyes. If the error persists, call for service.
63	Photoeyes activated with- out package.	Photoeyes dirty. Clean Photoeyes. Press the reset button F2. If the error persists, call for service.
65	Photoeyes not activated. - or - The package presence sensor has been accidentally activated.	The package has not reached the photoeye. - or - Rearrange tray on infeed. If the error persists, call for service.
66	Infeed start switch continuously activated.	Check the mechanical operation of the infeed start switch. Check if switch is jammed. If problem persists, call for service.
67	Package not placed against the start switch properly.	The first horizontal photoeye has not been activated. Rearrange the tray on infeed belts. If the problem persists, call for service.
71-78	Internal Machine Errors.	Press the reset button F2. If the error persists, call for service.
99 Blink	Multiple photoeyes malfunctioning.	Check and clean photoeyes. If the error persists, call for service.

METTLER TOLEDO

1900 Polaris Parkway
Columbus, Ohio 43240

Specifications subject to change without notice.

©2012 Mettler-Toledo, LLC

METTLER TOLEDO® AND SOLO® are registered
trademarks of Mettler-Toledo, LLC

Printed in USA



64081951